

## FITTING INSTRUCTION

Clamp mark in acc. with		Cables joining
ISO	PN	
1	L	Left directional lights
2	+	Rear fog lights
3	31	Ground
4	R	Right directional lights
5	58R	Right side parking lights
6	54	Stoplights
7	58L	Left side parking lights

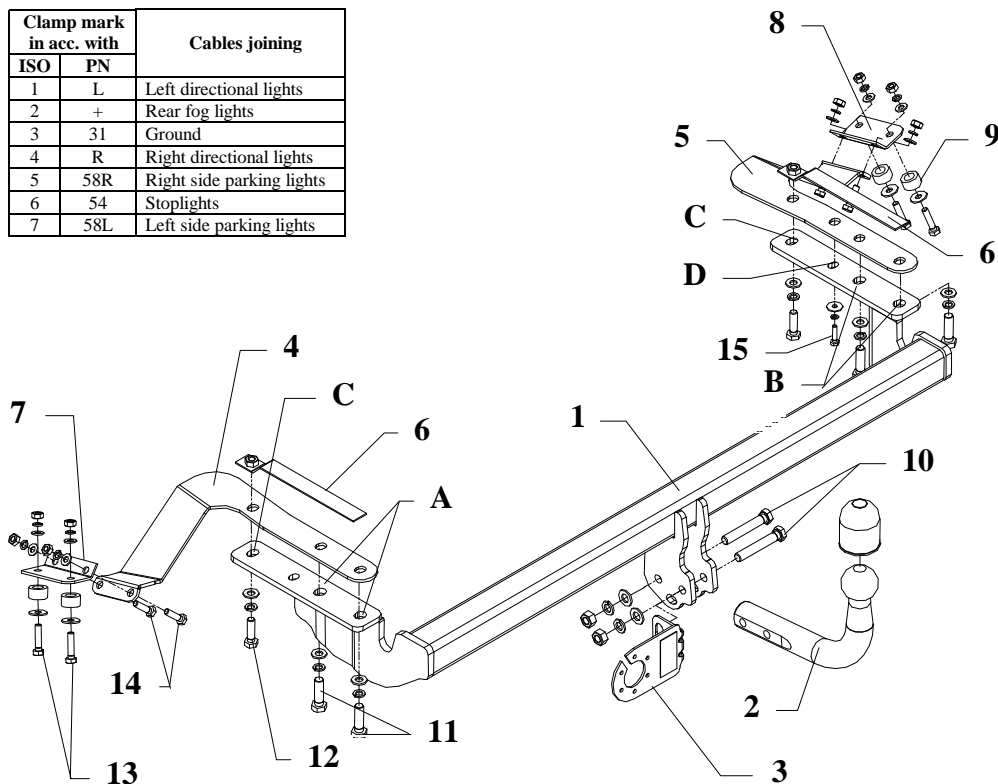

This towbar is designed to assembly in following cars:  
**TOYOTA AVENSIS 4-5 door**, produced since 01.2003 till 2009,  
 catalogue no. **055** and is prepared to tow trailers max total weight **1400 kg**  
 and max vertical load **56 kg**.

### *From manufacturer*

Thank you for buying our product. Their reliability has been confirmed in many tests. Reliability of towbar depends also on correct assembly and right operation. For this reasons we kindly ask to read carefully this instruction and apply to hints.

*The towbar should be install in points described by a car producer.*

## The instruction of the assembly

1. Disassemble the bumper together with plastic cover.
2. Unscrew original tow handles (not used any more) and metal reinforcement of the bumper.
3. Unscrew the muffler and thermal shield.
4. Put main bar of the towbar (pos. 1) and elements 4 and 5 (see draw.) to the chassis members in that way so towbar holes (pos. A and B) agree with fabric threaded holes and screw all using bolts M12x1,25x40mm (pos. 11).
5. Insert elements with nuts M10 (pos. 6) to chassis members in that way so holes agree with holes (pos. C) and fix all using bolt M10x35mm (pos. 12).
6. Elements 4 and 5 screw through original holes in body using bolts M8x35mm (pos. 13) using elements (pos. 7 and 8) and sleeves 25x14 (pos. 9) - sleeves inside the boot-see drawing.
7. Screw thermal shield using three original bolts and fourth (pos. 15) take from the towbar accessories (M6x25mm).
8. Screw the bumper.
9. Assemble the muffler.
10. Fix tow-ball (pos. 2) and socket plate (pos. 3) using bolts M12x75mm (pos. 10) from accessories.
11. Fix all bolts according to the torque shown in the table.
12. Connect electric wires of 7-poles socket according to the instruction of the car. (Recommend to make at authorized service station).
13. Supplement the paint coating damaged during assembly.

Torque settings for nuts and bolts (8,8):	
<b>M 8</b> - 25 Nm	<b>M 10</b> - 55 Nm
<b>M 12</b> - 85 Nm	<b>M 14</b> - 135 Nm











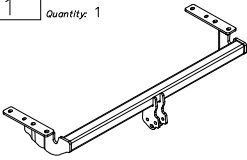









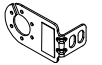





### NOTE

After install the towbar you should get adequate note in registration book (at authorised service station).The car should be equipped with:

- Indicators
- Tow mirrors

After 1000km of exploitation check all bolts and nuts. The ball of towbar must be always kept clear and conserve with a grease.

## Towbar accessories:

Pos. 1 Name: Main bar Quantity: 1 	Pos. 7 Name: Left plate Quantity: 1 Dim.: 90x85x3mm 	Pos. 14 Name: Bolt 8,8 B Quantity: 4 Dim.: M8x30mm 	Pos. 21 Name: Plain washer Quantity: 2 Dim.: Ø 10,5 mm 
	Pos. 8 Name: Right plate Quantity: 1 Dim.: 90x85x3mm 	Pos. 15 Name: Bolt 8,8 B Quantity: 1 Dim.: M6x25mm 	Pos. 22 Name: Plain washer Quantity: 8 Dim.: Ø 8,5 mm 
Pos. 2 Name: Tow ball Quantity: 1 	Pos. 9 Name: Sleeve Quantity: 4 Dim.: Ø25xØ15 L=14mm 	Pos. 16 Name: Nut 8 B Quantity: 2 Dim.: M12 	Pos. 23 Name: Spring washer Quantity: 6 Dim.: Ø 12,2 mm 
Pos. 3 Name: Socket plate Quantity: 1 	Pos. 10 Name: Bolt 8,8 B Quantity: 2 Dim.: M12x75mm 	Pos. 17 Name: Nut 8 B Quantity: 8 Dim.: M8 	Pos. 24 Name: Spring washer Quantity: 2 Dim.: Ø 10,2 mm 
Pos. 4 Name: Left fish-plate Quantity: 1 Dim.: 327x252x4mm 	Pos. 11 Name: Bolt 8,8 B Quantity: 4 Dim.: M12x1,25x40mm 	Pos. 18 Name: Plain washer Quantity: 4 Dim.: Ø24xØ9x2 mm 	Pos. 25 Name: Spring washer Quantity: 8 Dim.: Ø 8,2 mm 
Pos. 5 Name: Right fish-plate Quantity: 1 Dim.: 327x252x4mm 	Pos. 12 Name: Bolt 8,8 B Quantity: 2 Dim.: M10x35mm 	Pos. 19 Name: Plain washer Quantity: 1 Dim.: Ø22xØ7x1,5 mm 	Pos. 26 Name: Spring washer Quantity: 1 Dim.: Ø 6,2 mm 
Pos. 6 Name: Jib with the nut Quantity: 2 Dim.: 220x25x2mm 	Pos. 13 Name: Bolt 8,8 B Quantity: 4 Dim.: M8x35mm 	Pos. 20 Name: Plain washer Quantity: 6 Dim.: Ø 13 mm 	Pos. 27 Name: Ball cover Quantity: 1 



**PPUH AUTO-HAK S.J.**

Produkcja Zaczepów Kulowych  
Henryk & Zbigniew Nejman  
76-200 SŁUPSK ul. Słoneczna 16K  
tel/fax (059) 8-414-414; 8-414-413  
E-mail: office@autohak.com.pl  
www. autohak.com.pl

## Towing hitch (without electrical set)

Class: **A50-X** Cat. no. **O55**

Designed for:

Manufacturer: **TOYOTA**

Model: **AVENSIS**

Type: **4-5 door**

produced since 01.2003 till 2009

Technical data:

**D-value: 7,89 kN**

maximum trailer weight: **1400 kg**

maximum vertical cup load: **56 kg**

Approval number acc. to regulations EKG/ONZ 55.01: **E20-55R-01 1245**

## Foreword

This towbar is designed according to rules of safety traffic regulations. The towing hitch is a safety component and can be install only by qualified personnel. Any alteration or conversion of the towing hitch is prohibited and would lead to cancellation of design certification. Remove insulating compound and underseal from vehicle (if present) in the area of the matting surfaces of the towing hitch. The vehicle manufacturer's specifications regarding trailer load and max. vertical cup load are decisive for driving, and values for the towing hitch cannot be exceeded.

*D-value formula:*

$$\frac{\text{Max trailer weight [kg]} \times \text{Max vehicle weight [kg]}}{\text{Max trailer weight [kg]} + \text{Max vehicle weight [kg]}} \times \frac{9,81}{1000} = D \text{ [kN]}$$